

RAMSA 3

Art.-Nr.

405 182
405 183
405 184
405 185

1110
1790
516
mm

1/10
VO
04-2025

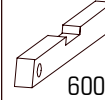
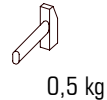
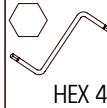
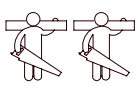



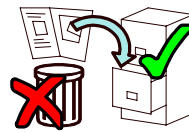
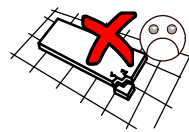
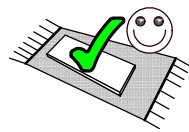
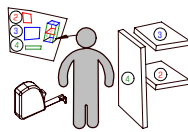
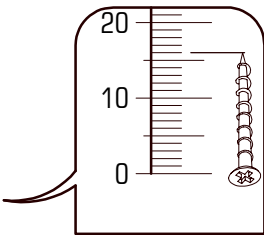
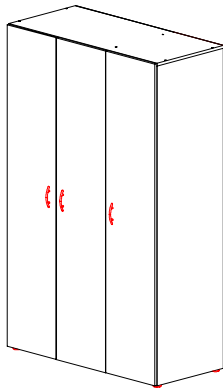
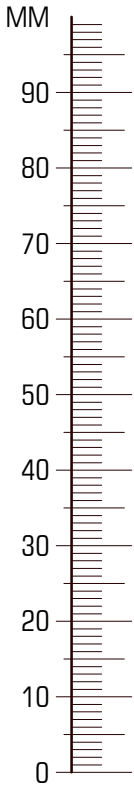
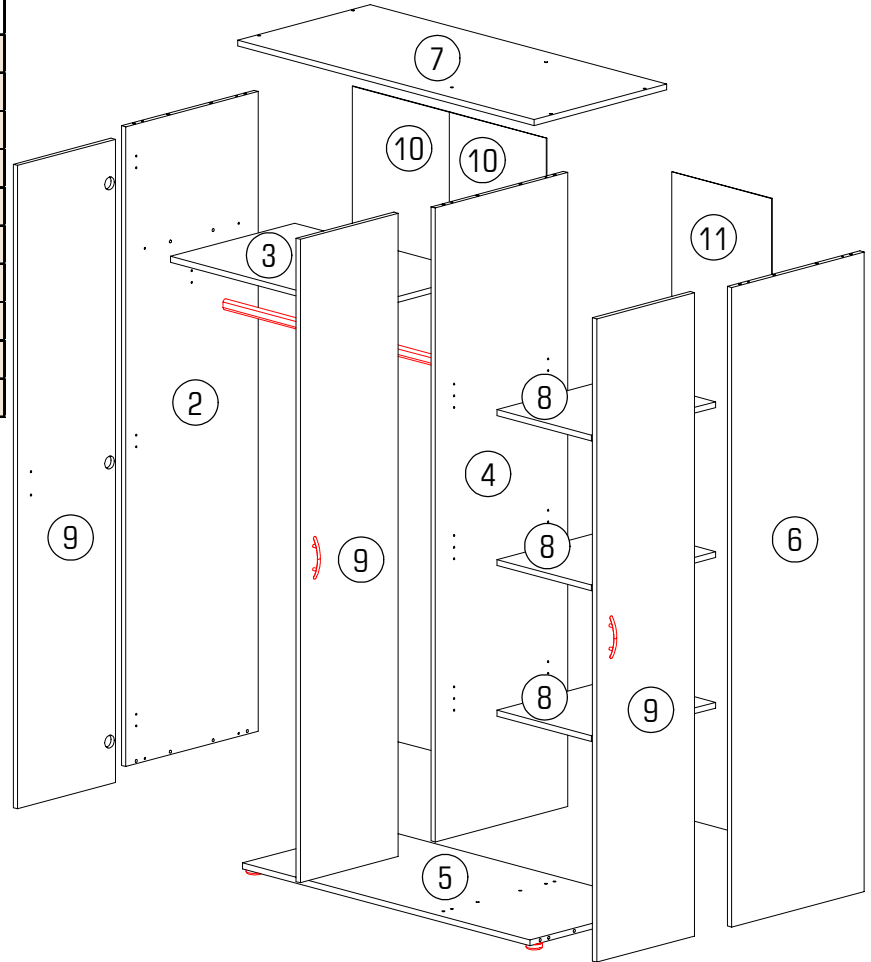

| ID | ID | ID | ID | ID |
|-------|----|-------------|----|-----|
| 21903 | ② | 1758*496*16 | 1x | 1/3 |
| 21904 | ③ | 706*465*16 | 1x | 2/3 |
| 21910 | ④ | 1742*496*16 | 1x | 1/3 |
| 21911 | ⑤ | 1076*495*16 | 1x | 2/3 |
| 21912 | ⑥ | 1758*496*16 | 1x | 1/3 |
| 21913 | ⑦ | 1110*497*16 | 1x | 2/3 |
| 21914 | ⑧ | 354*465*16 | 3x | 2/3 |
| 21907 | ⑨ | 1768*366*16 | 3x | 3/3 |
| 21915 | ⑩ | 1768*363*3 | 2x | 3/3 |
| 21916 | ⑪ | 1768*374*3 | 1x | 3/3 |

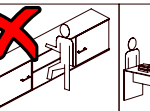
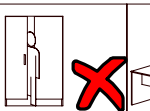
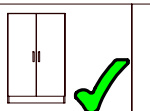



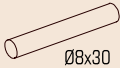
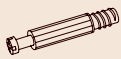

| | | | | | | |
|---------------------|--------------------|---------------------|-----------------|---------------------|-----------------|----------|
| 22244.01 Ø3,5x16 | 22800.01 | 22300.00 | 27000.00 | 21102.00 | 70013.01 | 70021.01 |
| A 4x | B 6x | C 1x | D 8x | F 28x | G 75x | H 8x |
| 22280.00 Ø4x30 | 30080.00 Ø44x15 | 32305.00 L=118 | 24101.00 Ø10 | 22243.00 Ø3,5x15 | 24008.00 3,0 | 35101.01 |
| K 6x | L 5x | M 3x | N 4x | P 2x | Q 22x | R 18x |
| 70018.01 | 70017.04 L=701 | 22256.00 Ø5,0x70 | 31103.00 | 22236.00 Ø2,5x16 | 36002.07 | 36002.07 |
| T1 2x | T2 1x | U 2x | V 2x | W 18x | Y1 9x | Y2 9x |
| | | | | | | Z 5x |

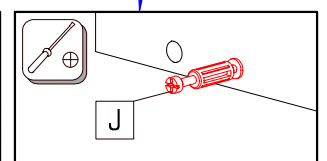
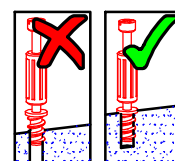
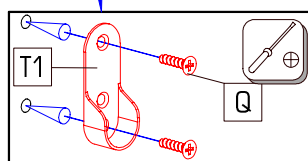
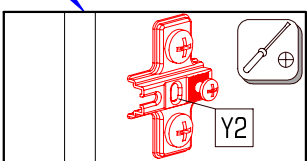
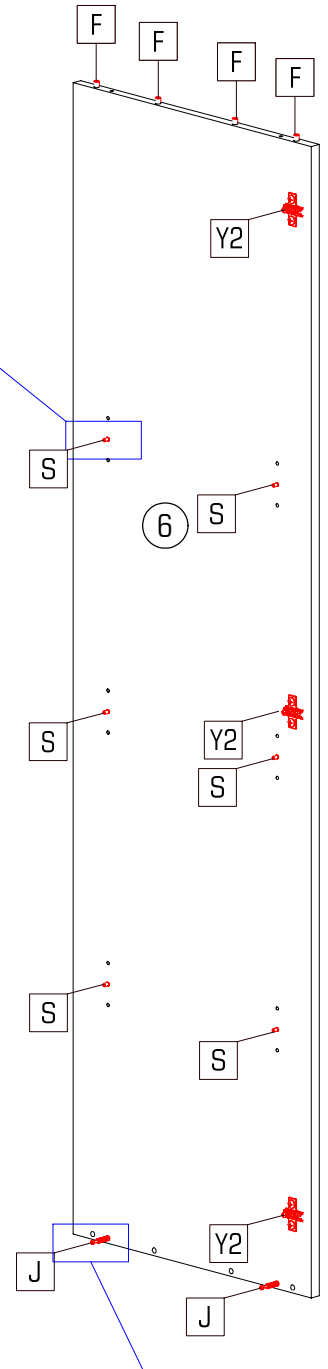
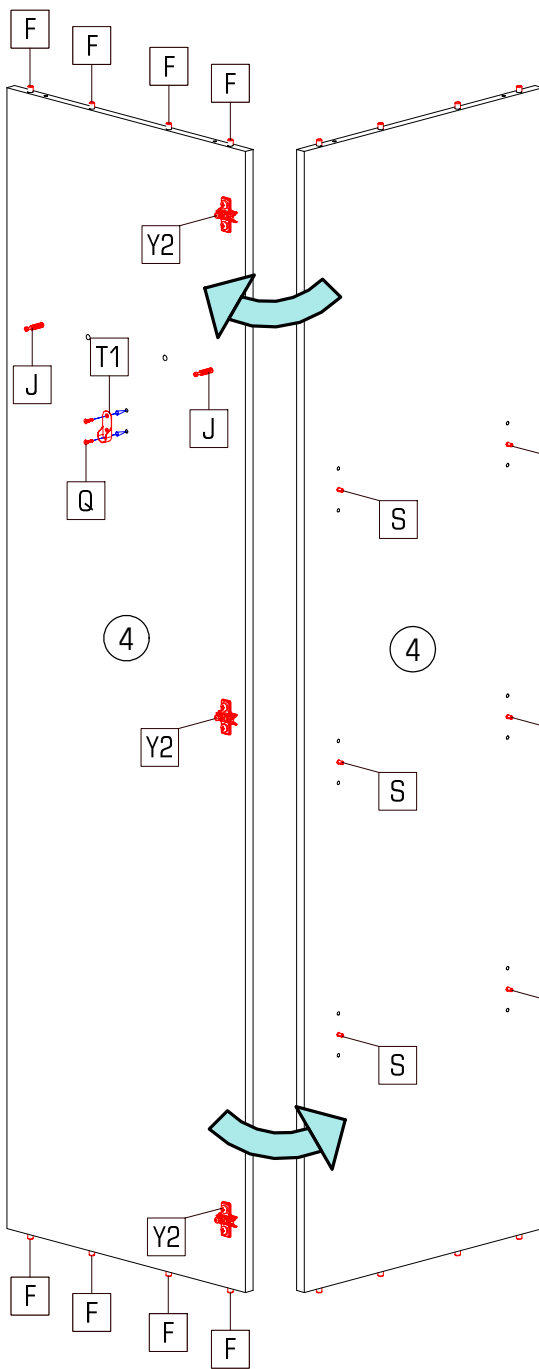
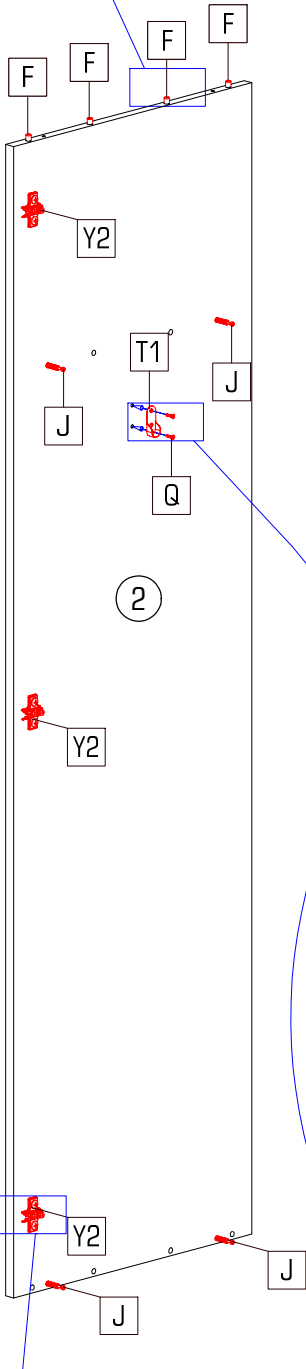
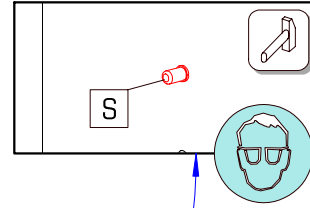
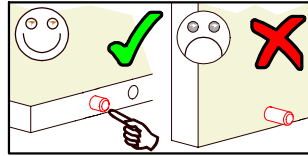
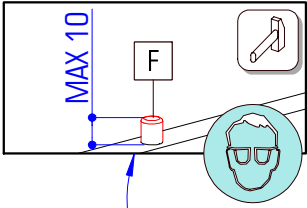
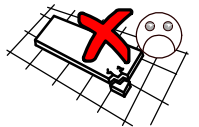
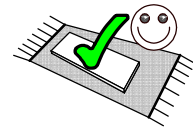

2/10 RAMSA 3

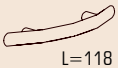

| | | | | | |
|--|---|---|---|---|---|
|  |  |  |  |  |  |
| F 16x | J 8x | Q 4x | S 12x | T1 2x | Y2 9x |



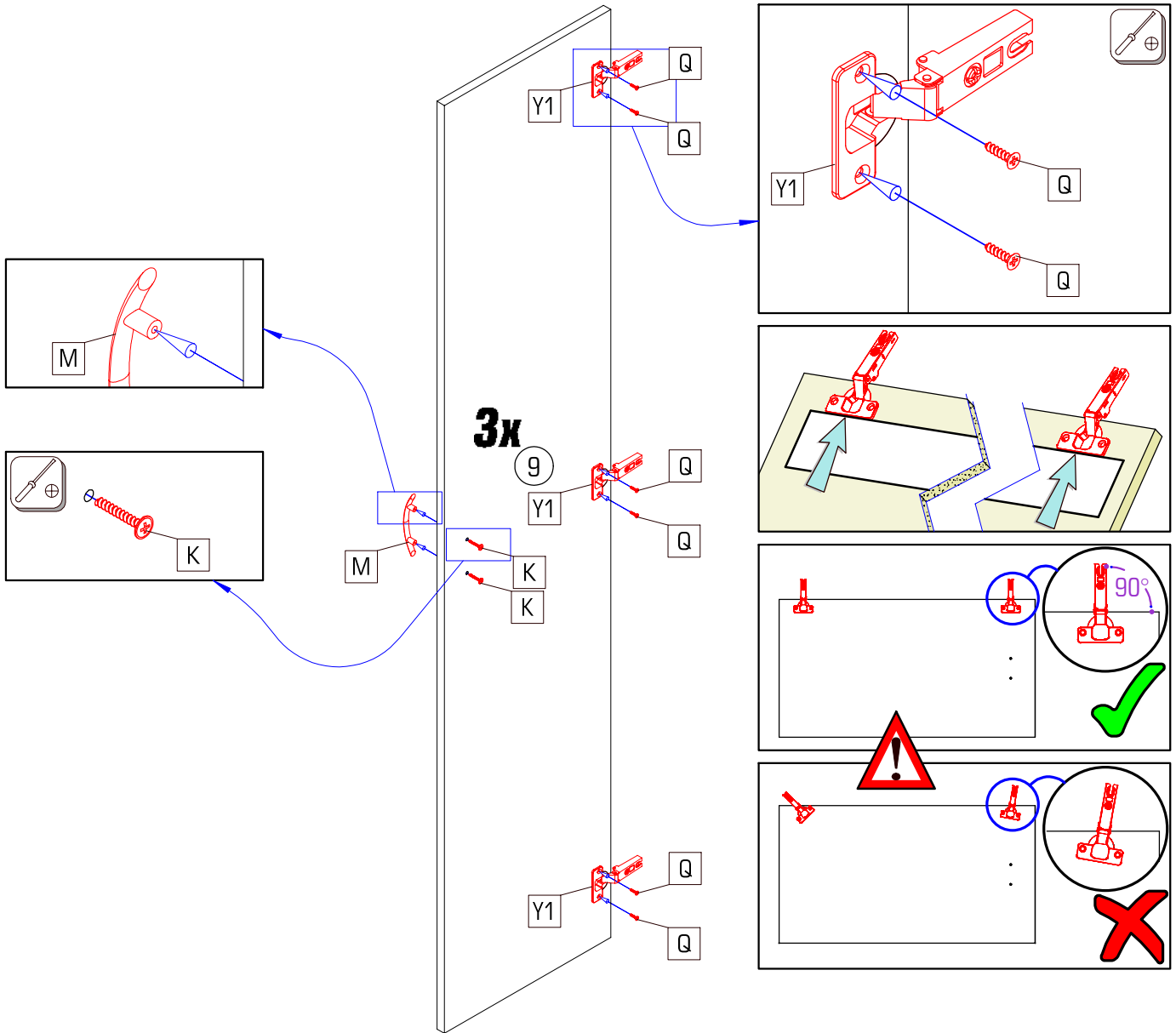
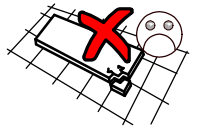
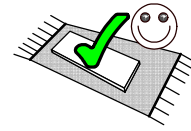

| | | | |
|--|---|---|---|
|  |  |  |  |
| K 6x | M 3x | Q 18x | Y1 9x |

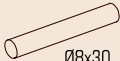

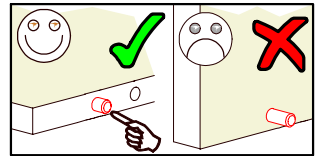
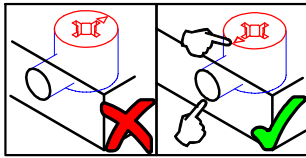
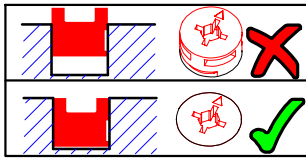
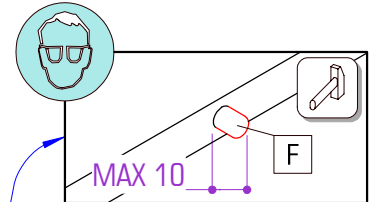
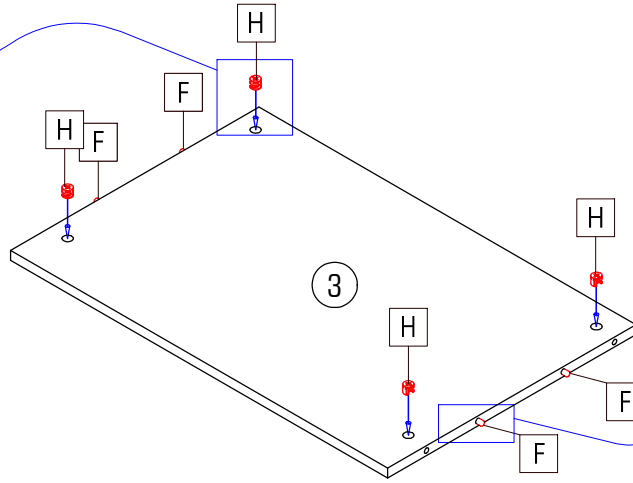
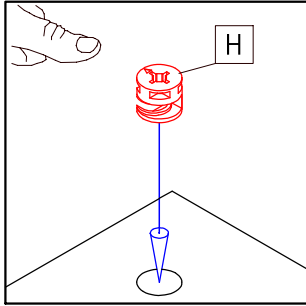
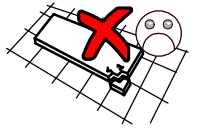
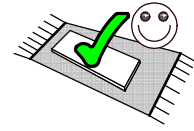

4/10 RAMSA 3

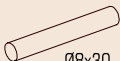
| | | | |
|--|---------------------------|---|----------------------------|
|  | $\varnothing 8 \times 30$ |  | $\varnothing 15 \times 13$ |
| F | 4x | H | 4x |

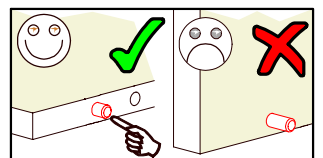
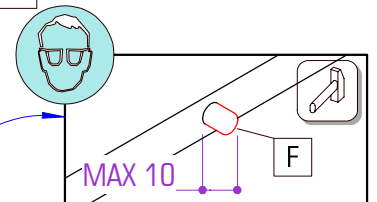
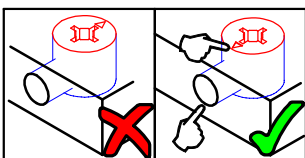
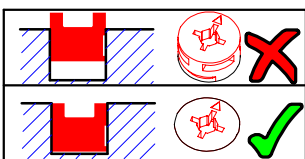
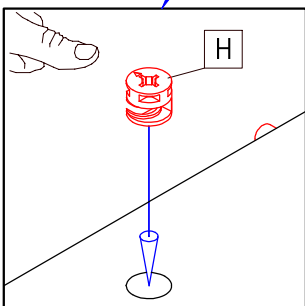
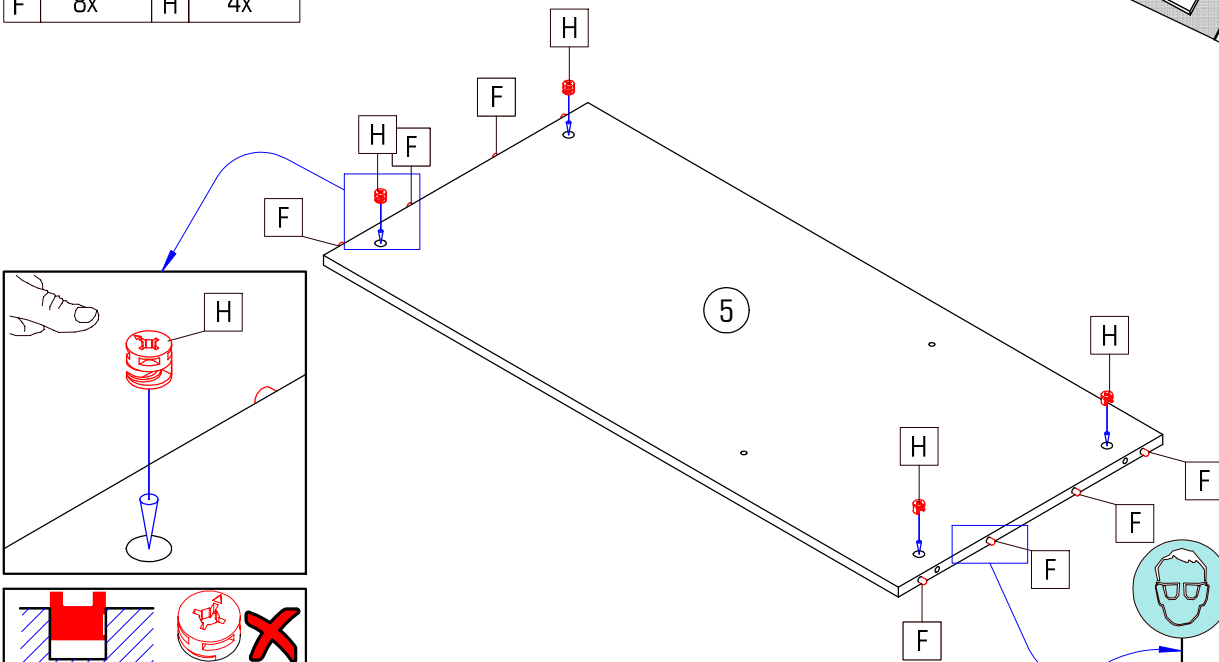
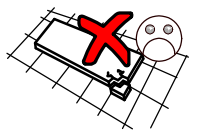
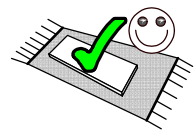

| | | | |
|--|---------------------------|---|----------------------------|
|  | $\varnothing 8 \times 30$ |  | $\varnothing 15 \times 13$ |
| F | 8x | H | 4x |





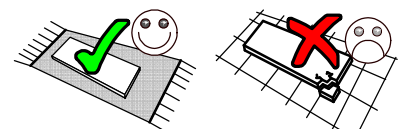
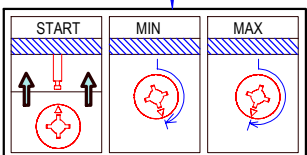
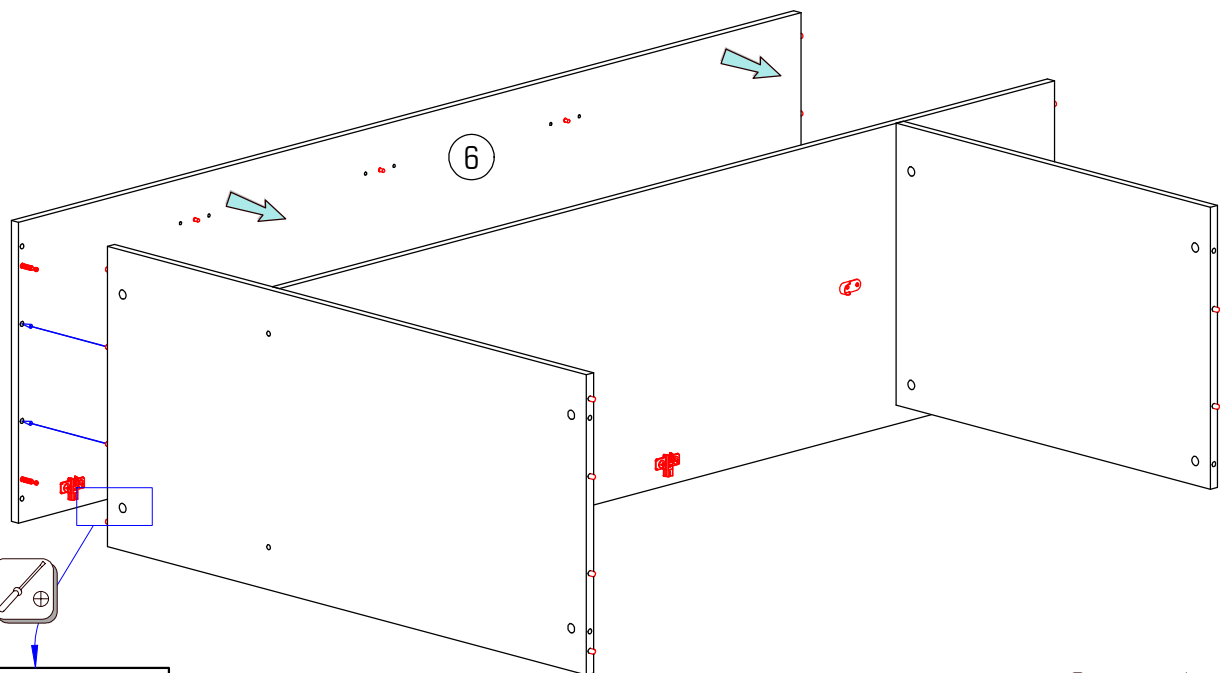
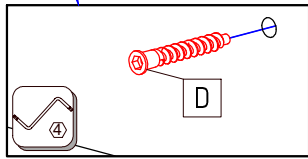
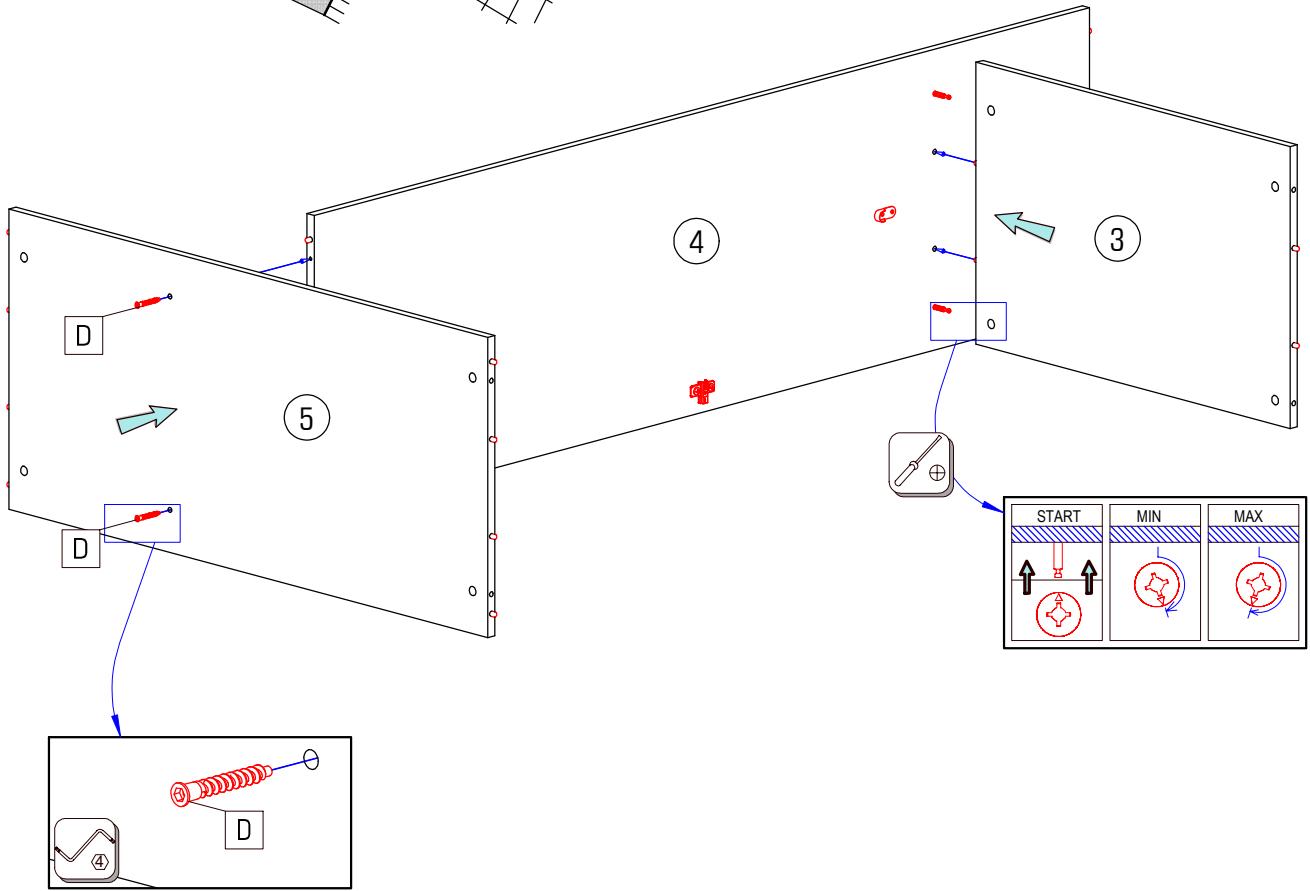
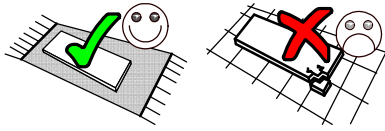

 Ø7x50
D 2x

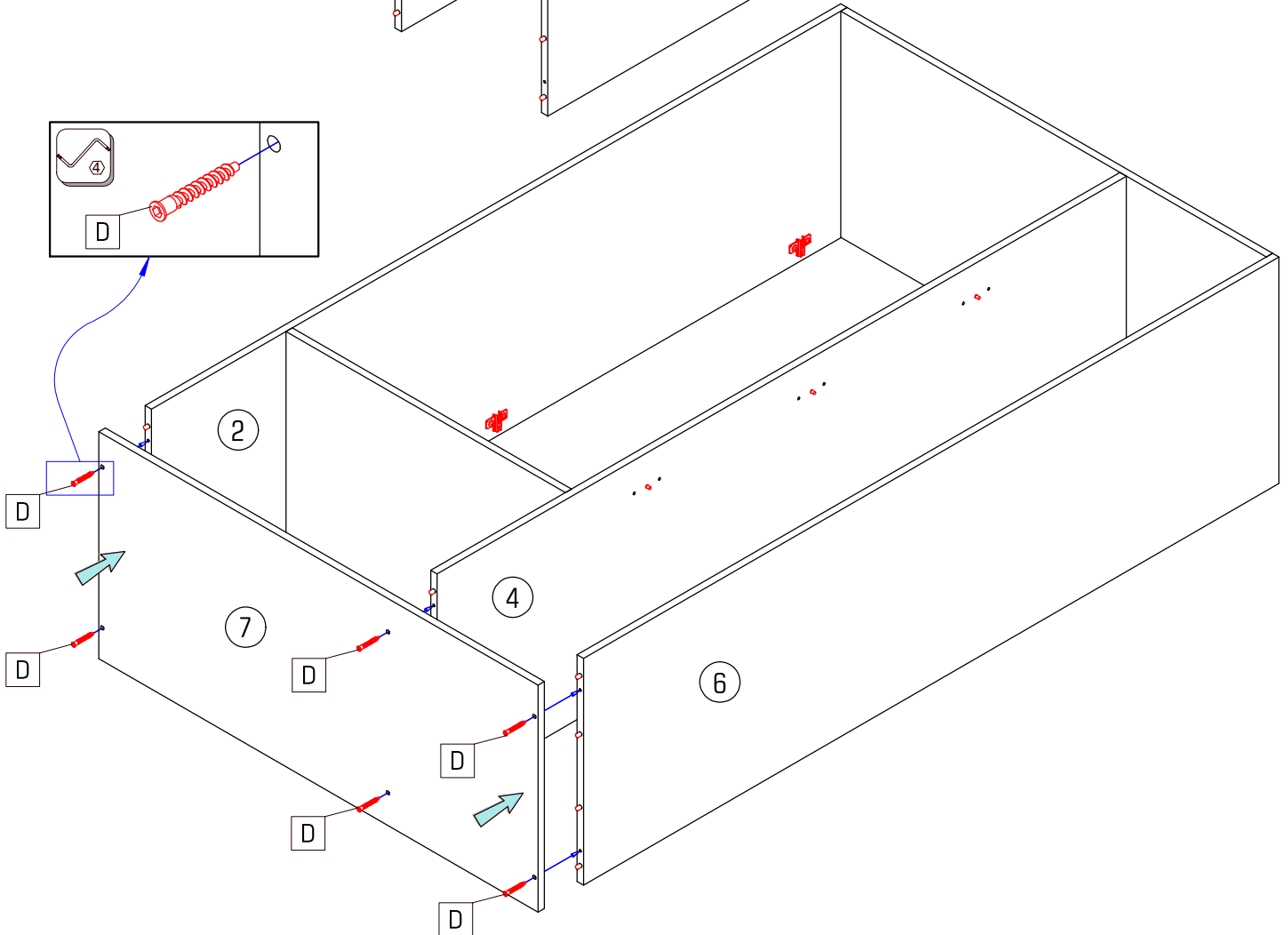
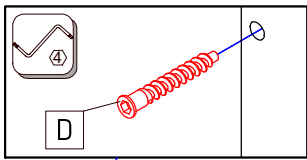
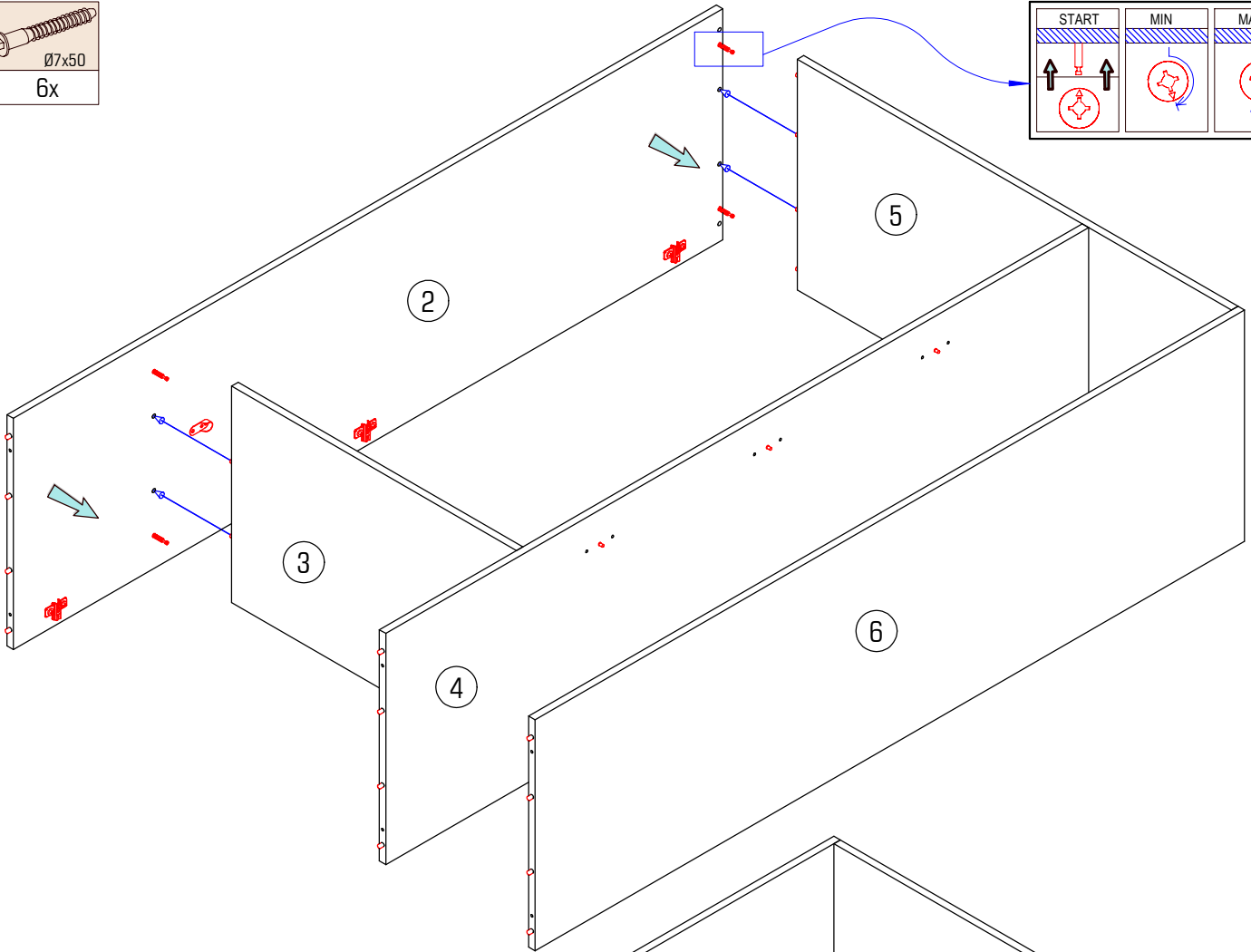
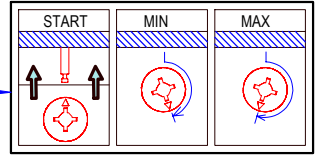
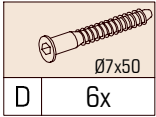

6/10 RAMSA 3



| | | | | |
|--|---|---|---|---|
|  |  |  |  |  |
| Ø1,6x20 | Ø44x15 | 3,0 | Ø2,5x16 | Ø4x25 |
| G 75x | L 5x | R 18x | W 18x | Z 5x |

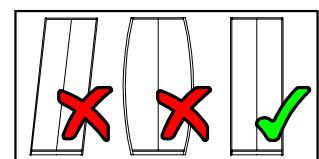
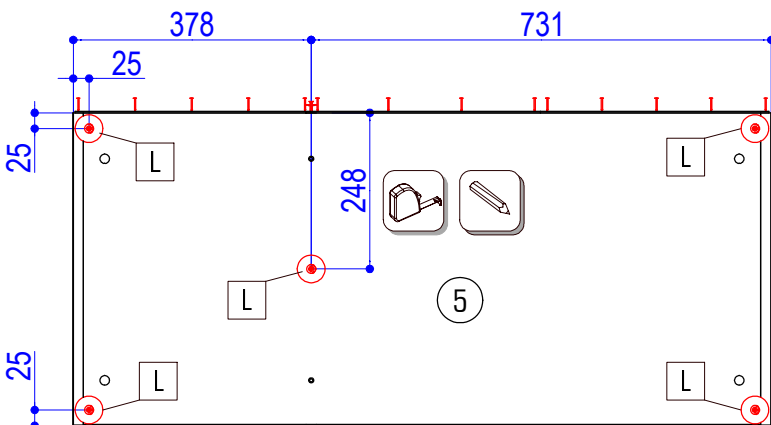
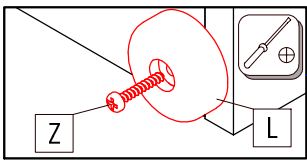
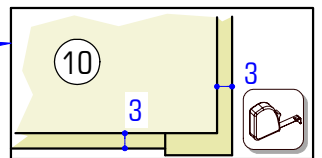
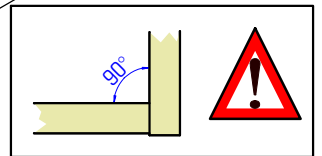
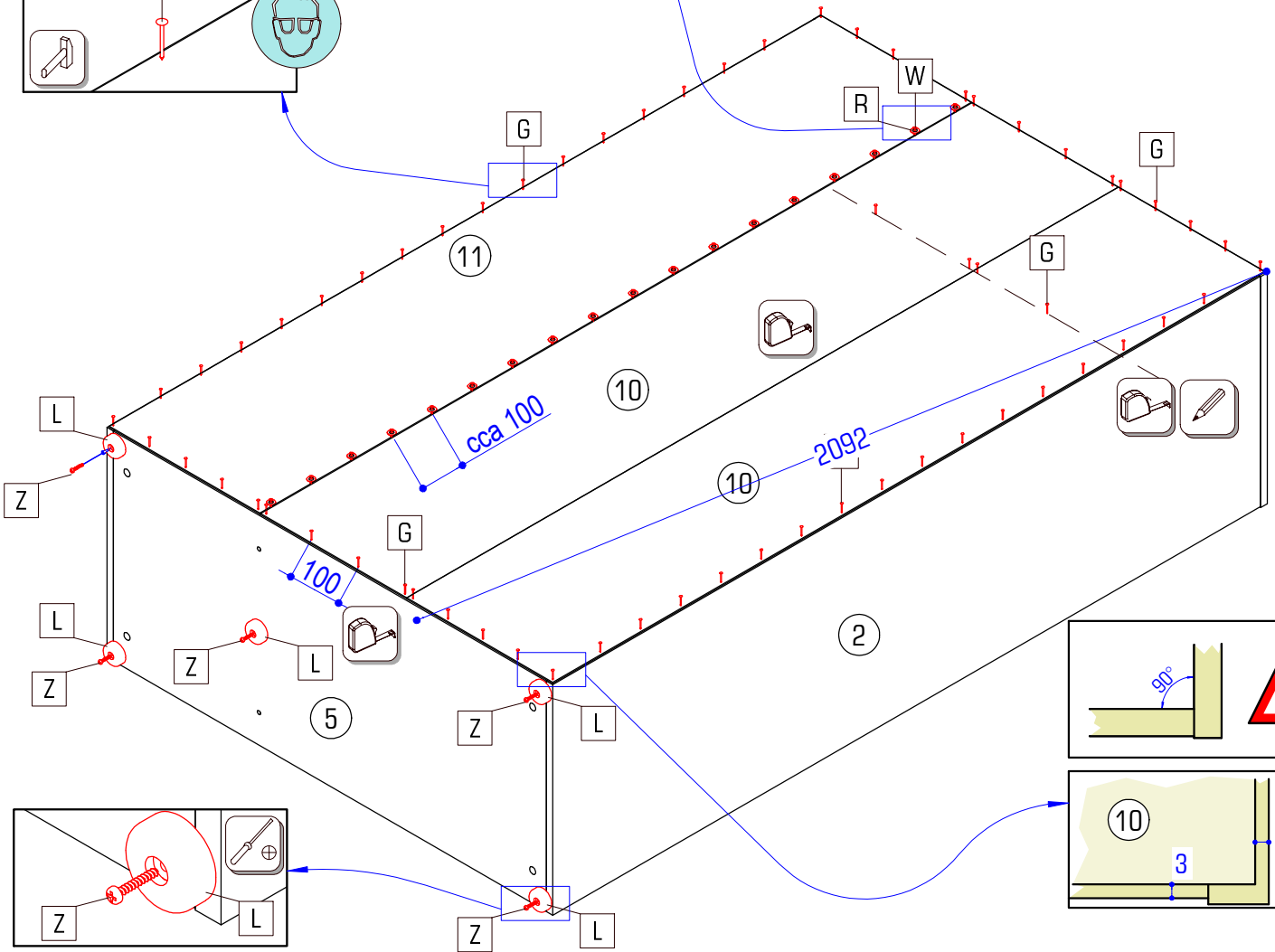
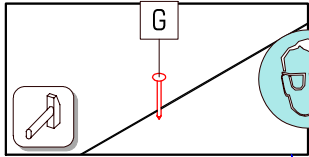
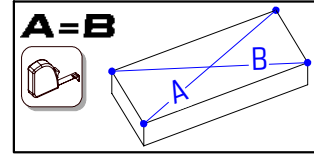
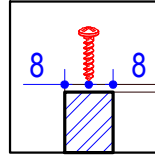
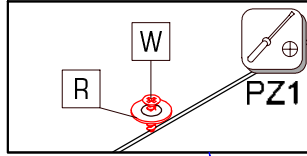
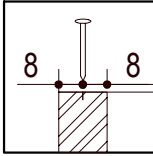
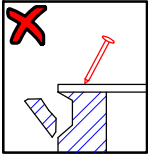
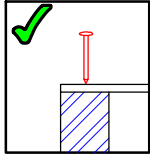
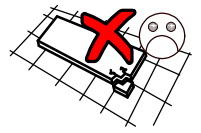
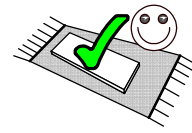

8/10 RAMSA 3

| | | | | | | | | | |
|------|------|------|------|-------|------|------|--|--|--|
| | | | | | | | | | |
| A 4x | B 6x | N 4x | P 2x | T2 1x | U 2x | V 2x | | | |

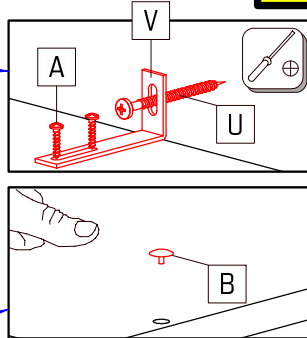
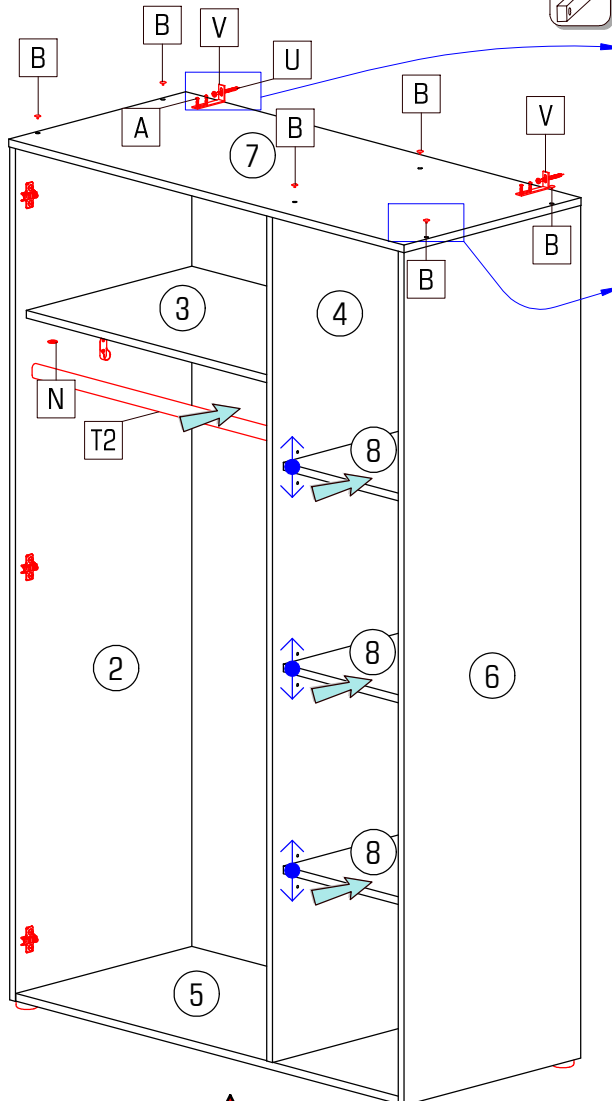
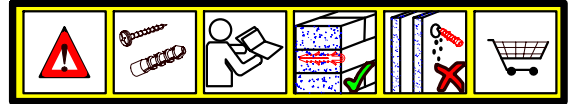
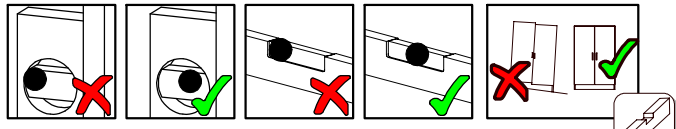
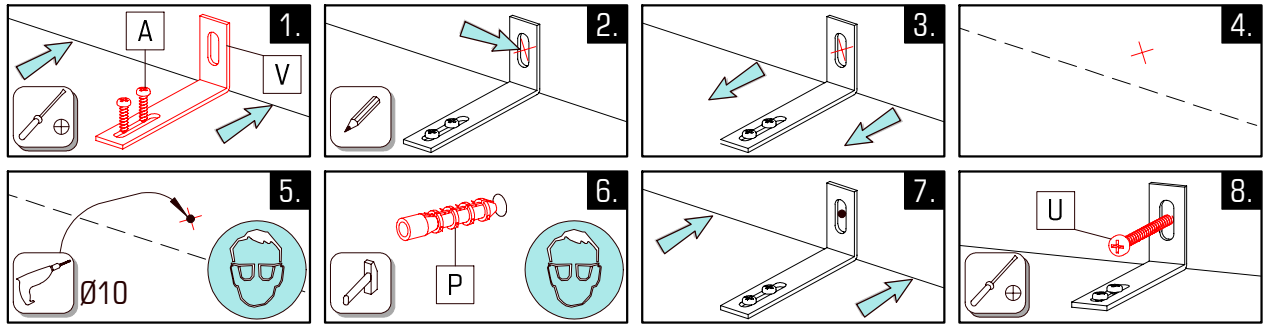

PL Uwaga! Ścianę należy sprawdzić przed montażem. Dołączone uniwersalne kołki rozporowe są odpowiednie tylko do stosowania w mocnych murach, takich jak beton lub cegła. Nie rób za pomocą kołków oporowych murowanych, takich jak pustak, lekka kostka, powierzchnie takie jak płyty gipsowo-kartonowe lub inne systemy ram. Jeśli dotyczy, muszą to być określone kołki rozporowe być użytymi! Są one dostępne w specjalistycznym sklepie niezgodność, producent / sprzedawca lub importer nie ponoszą odpowiedzialności.

DE Achtung! Die Wandbeschaffenheit ist vor der Montage unbedingt zu prüfen. Die beigelegten Universaldübel sind ausschließlich nur zur Verwendung für festes Mauerwerk wie Beton/Ziegel. Die Mauerdübel dürfen nicht bei Mauerwerk wie Hohlraumziegel, Leichtbausteine, Gipskartonplatte oder anderer Rahmenbauweise verwendet werden. Bei diesen Mauerwerken sind gegebenenfalls Spezialdübel zu verwenden! Diese sind in einem Fachgeschäft erhältlich. Bei Nichteinhaltung wird seitens Produzenten/Händler und Importeur keine Haftung übernommen.

EN Caution! The wall must be examined before assembly. The included universal wall plugs are only suitable for using in firm masonry such as concrete block or brick. Do not use the wall plugs masonry such as hollow brick, lightweight block, surfaces such as gypsum plasterboard or other framing systems. If applicable, particular wall plugs must be used! These are available at a specialised store (hardware store). In case of non-compliance, the manufacturer/retailer or importer do not assume liability.

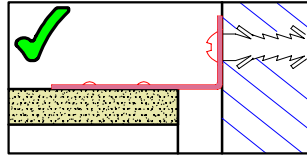
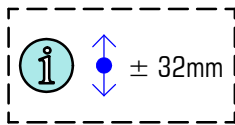

RO Prudență! Zidul trebuie examinat înainte de asamblare. Prizele de perete sunt adecvate numai pentru utilizarea în zidurile fermă, cum ar fi betonul bloc sau cărămidă. Nu folosiți zidurile zidurilor de perete, cum ar fi cărămida goală, blocul ușor, suprafețe cum ar fi gips-carton sau altă încadrare sisteme. Dacă este cazul, trebuie folosite anumite prize de perete! Acestea sunt disponibile la un magazin specializat (magazin de hardware). În caz de nerespectare, producătorul / vânzătorul cu amănuntul sau importatorul nu își asumă răspunderea.

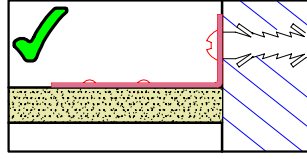

HR pažnja! Prije montaže obavezno provjerite svojstvo zida. Priložene univerzalne tiplje namijenjene su isključivo za masivne zidove od betona/opeke. Tiplje za masivne zidove ne smiju se koristiti za zidove kao npr. šupljina opeka laki sastavni elementi, gips-kartonske ploče ili drugi modularni načini gradnje. Za te zidove potrebne su eventualno posebne tiplje! Iste su dostupne u specijaliziranim trgovinama građevinskim materijalom. U slučaju nepridržavanja prethodno navedenih napomena, proizvođač/trgovac i uvoznik ne preuzimaju odgovornost!

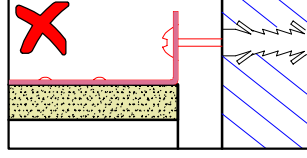

CZ Upozornění! Před montáží je nutné zkontrolovat stav stěny. Přiložené univerzální hmoždinky jsou určeny pouze k použití pro pevné zdivo jako beton/cihly. Hmoždinky do zdi se nesmí používat u dutinová cihla, zdiva jako porovité stavební kámen, sádkokartónová deska nebo jiný měkký materiál. U těchto zdiv jsou nutné použít speciální hmoždinky! Jsou k dostání v speciálních prodejnách se stavebním materiálem. Při nedodržení těchto pokynů výrobce/prodejce a dovozce neručí za způsobené škody.

SI Pozor! Pred montažo preverite stanje stene. Priloženi univerzalni mozniki so izključno samo za uporabo na čvrstem zidovju, kot sta beton in opeka. Stenski mozniki se ne smejo uporabljati pri zidovju kot so votlina opeke, zidaki za lahko gradnjo, mavčne plošče ali druge okvirne gradnje. Pri teh zidovjih morate v danih primerih uporabljati posebne moznike. Ti so na voljo v specializiranih trgovinah (trgovinah z gradbenim materialom) Pri upoštevanju se s strani proizvajalca/trgovca in uvoznika ne prevzame jamstvo.

HU Vigyázat! Szerelés előtt a falfelületet feltétlenül vizsgálja meg. A mellékelt univerzális tiplik kizárólag stabil falazathoz használható mint például beton/tégla. A fali tiplje nem használható könnyű építőkövekhez, üreg tégla, gipszkarton lapokhoz vagy más fázvas építőanyagokhoz. Ezekhez a falfelületekhez csak speciális tiplik használhatóak, melyek szaküzletekben (barkácsruházakban) beszerezhetőek. Figyelmen kívül hagyása esetén a gyártó/kereskedő vagy forgalmazó nem vállal felelősséget.

SK Upozornenie! Pevnosť steny sa musí pred montážou bezpodmienečne skontrolovať. Priložené univerzálne hmoždenky používajte jedine pre pevné murivo ako je beton/tehla. Hmoždenky sa nesmú používať v prípade ľahkého stavebného muriva, dutá tehla, Sádkokartónová deska, alebo iných konštrukcií rámu. U týchto stien je nutné použiť špeciálne hmoždenky! Tieto je možné dostať v špeciálnych predajniach so stavebným materiálom. Pri nedodržaní pokynov nepreberajú výrobca/predajca a dodávateľa zodpovednosť za vzniknuté škody.

| | |
|-----------|-------------|
| SK | VÝSTRAHA |
| CZ | VAROVÁNÍ |
| HR | UPOZORENIE |
| DE | WARNUNG |
| HU | FIGYELEM |
| PL | OSTRZEŻENIE |
| RO | AVERTIZARE |
| EN | WARNING |
| SI | OPOZORILO |

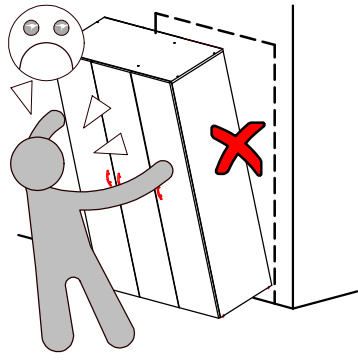

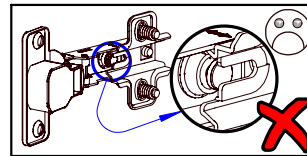
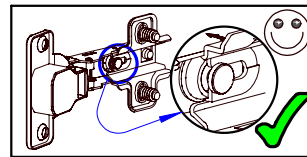
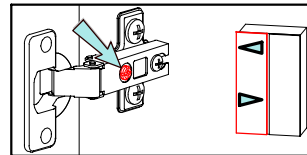
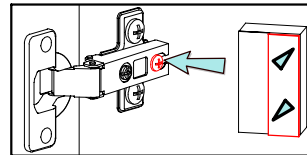
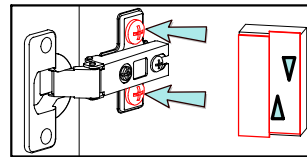
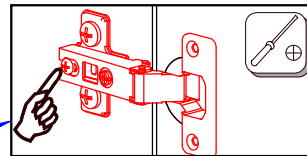
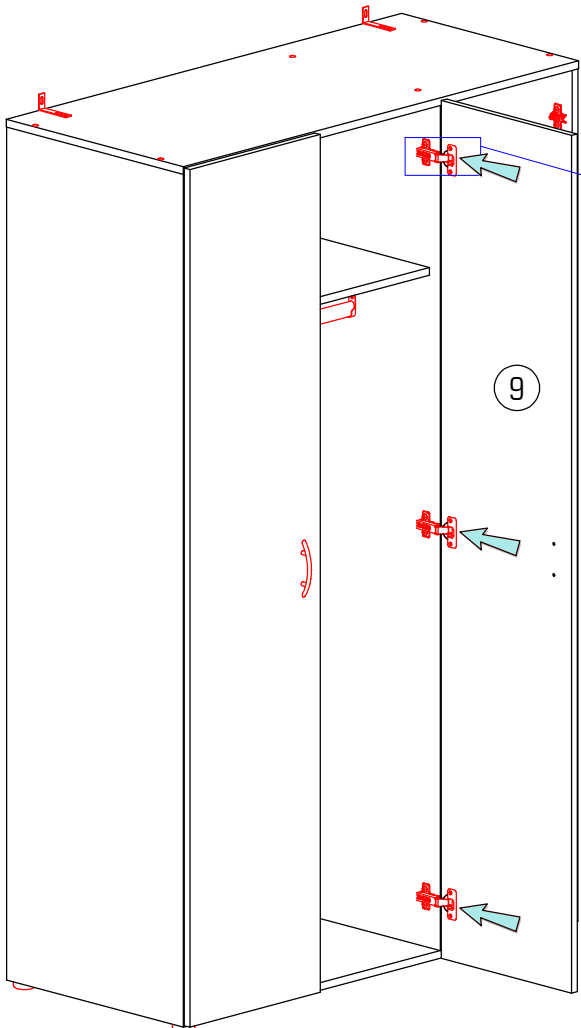
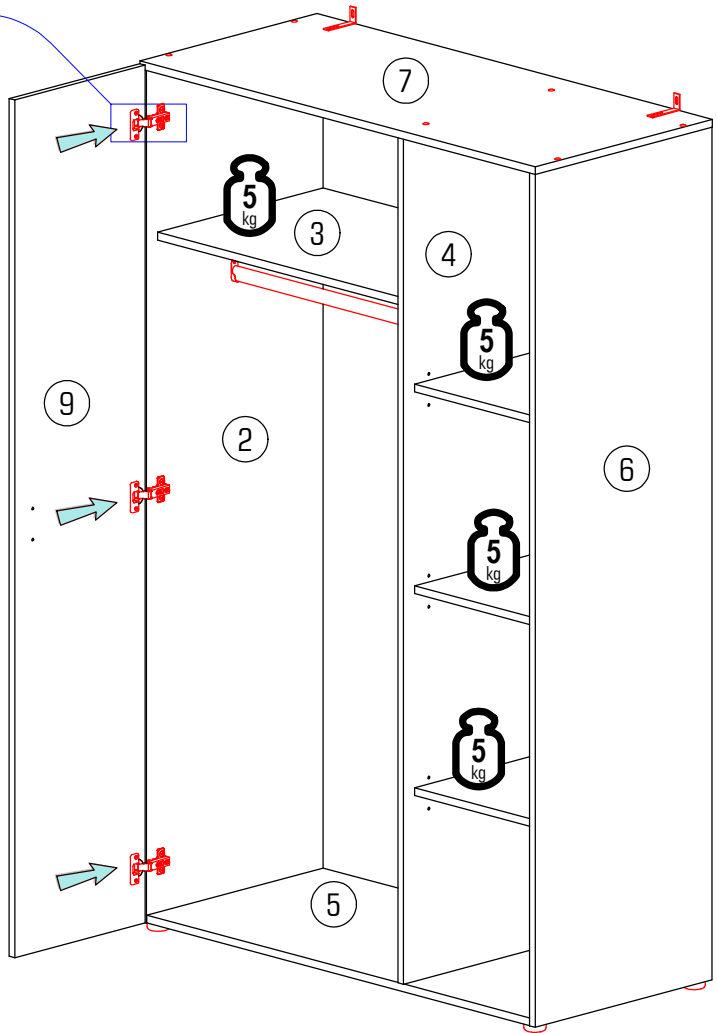
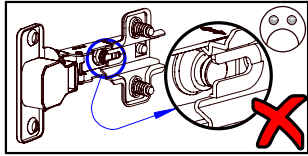
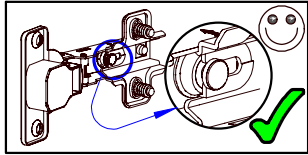
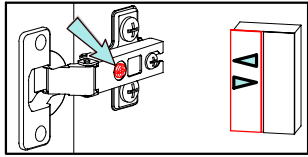
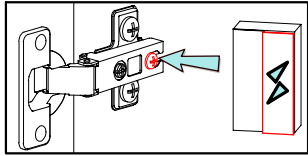
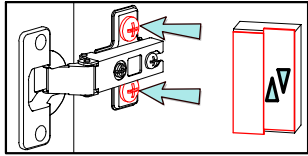
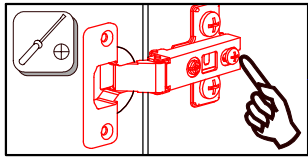

10/10 RAMSA 3

